

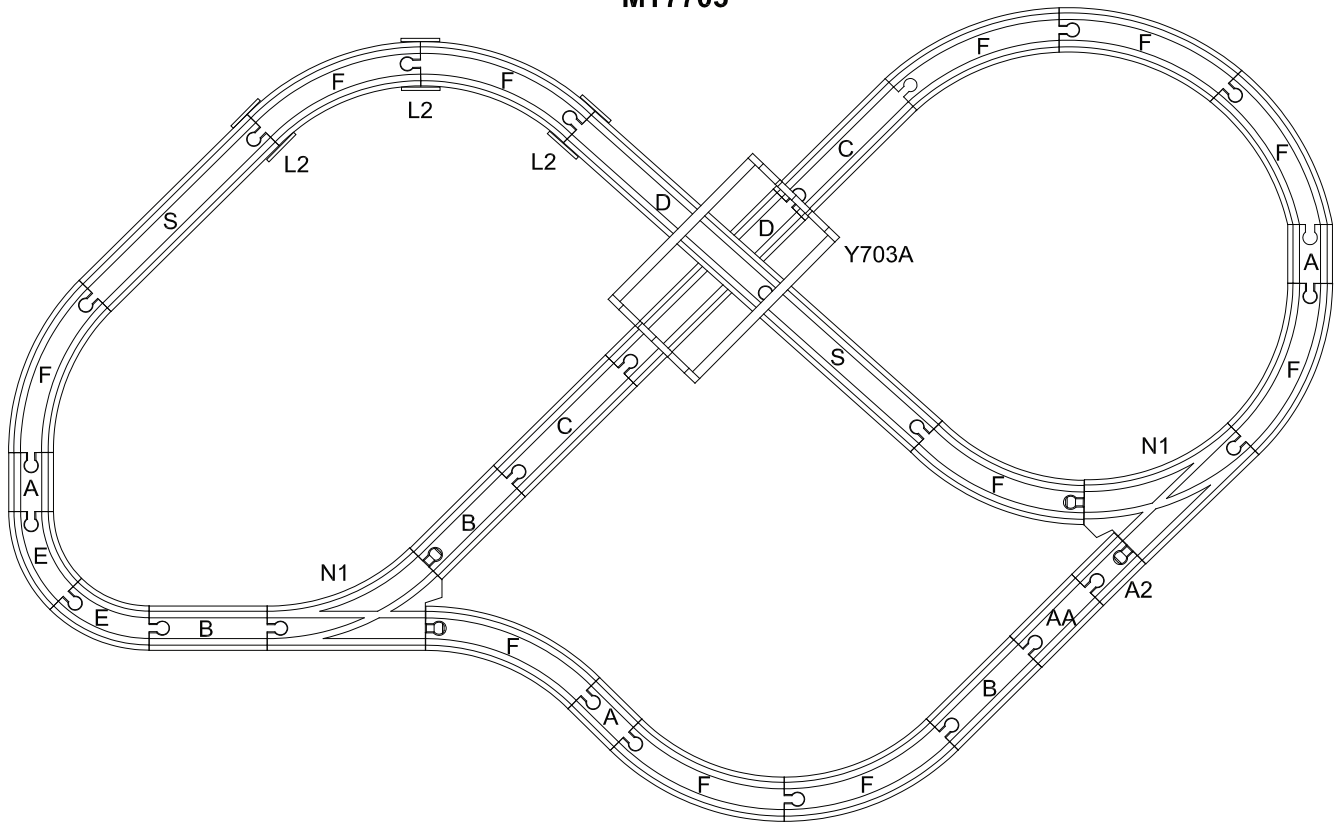











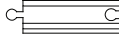
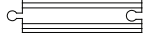



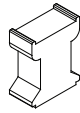

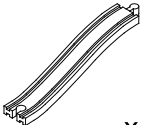
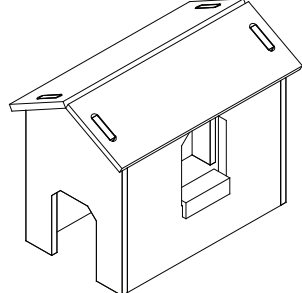
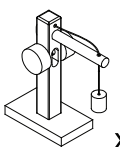



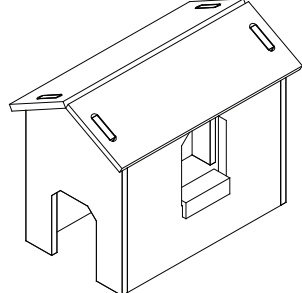

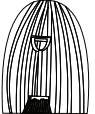
# ASSEMBLY INSTRUCTIONS

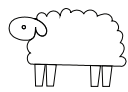
## MT7703

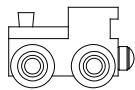
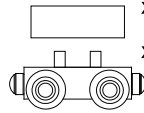
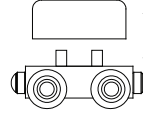
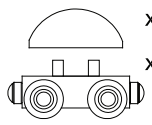

A	A2	AA	B	C	D	E
 x 3	 x 1	 x 1	 x 3	 x 2	 x 2	 x 2
F	L2	N1	S	Y703A		Y703B
 x 11	 x 3	 x 2	 x 2	 x 1		 x 1
Y703C	Y703D	Y703E2	Y703F			Y703G
 x 1	 x 1	 x 1	 x 1	 x 1		 x 1
Y703H	Y703I2	Y703N	Y703P			Y703Q
 x 1	 x 1	 x 1	 x 1	 x 2	 x 1	 x 1
Y703R3	Y703S	Y703T	Y703U	Y703V	Y703W	Y703X
 x 1	 x 1	 x 1	 x 1	 x 1 x 1 = 2	 x 1 x 1 = 2	 x 1 x 1 = 2

**ADULT ASSEMBLY REQUIRED.** This package contains small parts which are for adult assembly only. Please make sure all screws and bolts are securely fastened during assembly. Upon completion please double check before using the toy. Failure to follow assembly instruction will cause damages to the toy and potentially result in an injury to children.

**ASSEMBLY INSTRUCTIONS**  
Y703A

**HARDWARE**



19 MM

8 x

1

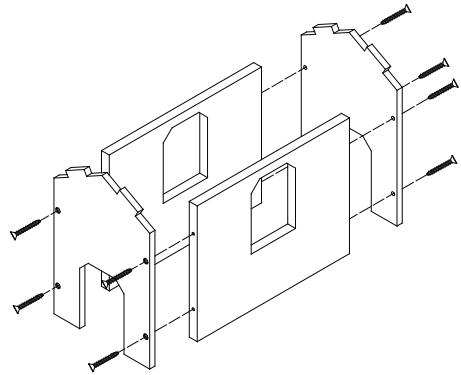

2

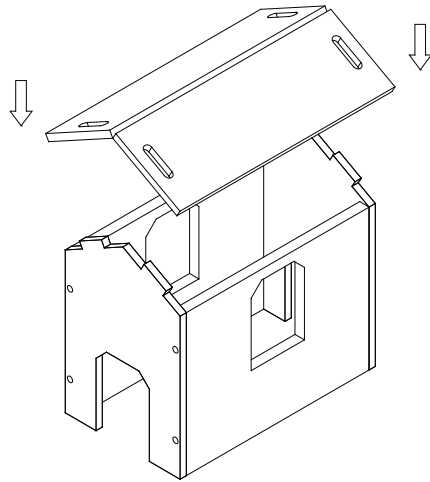

3

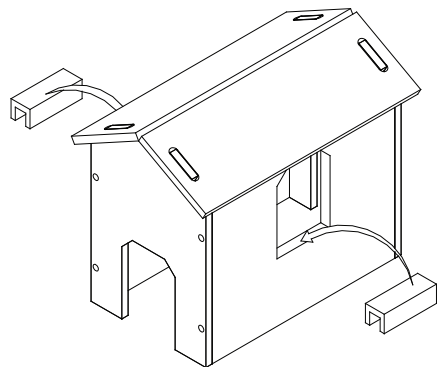

**Complete**

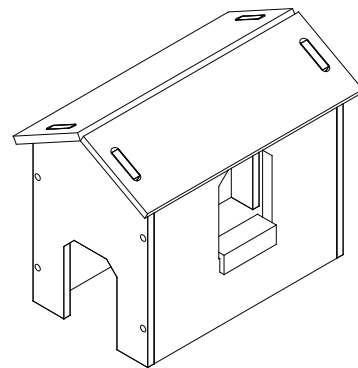

**ADULT ASSEMBLY REQUIRED. This package contains small parts which are for adult assembly only**