

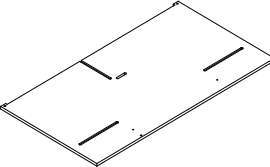

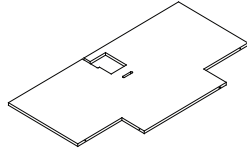

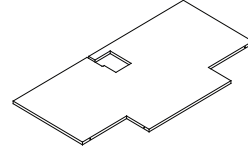

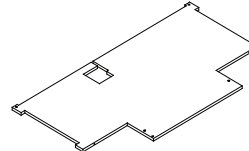

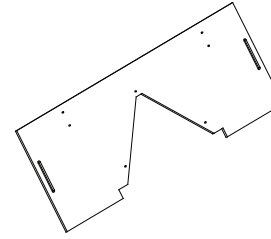
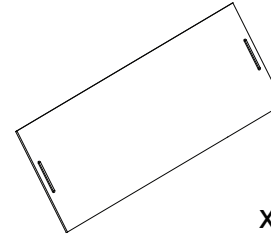
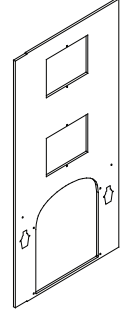
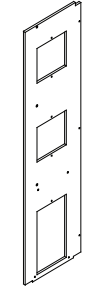
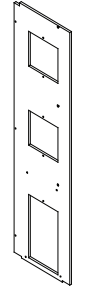

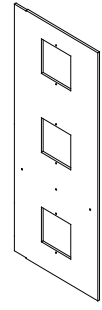
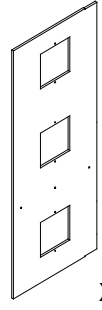
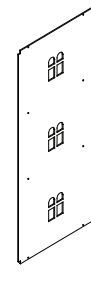
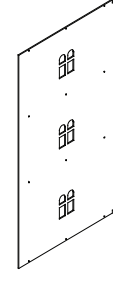
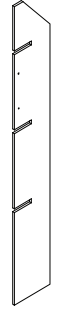
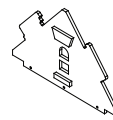

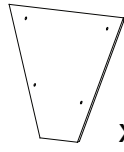
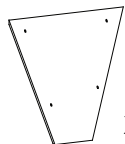
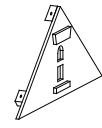



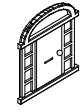

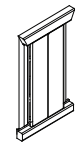





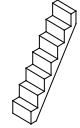

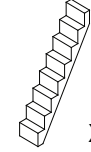

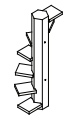



PART LIST / LISTA PARTI COMPONENTE

TL8126

A		B		C		D		E		F	
											
x1		x1		x1		x1		x1		x1	
G1	G2	G3	H1	H2	I1	I2	J1	J2	J3		
											
x1	x1	x1	x1	x1	x1	x1	x1	x1	x1		
K1	K2	L1	L2	M	N1	N2	N3	O1	O2	O3	
											
x1	x1	x1	x1	x1	x1	x1	x1	x1	x2	x10	
P	Q1	Q2	Q3	Q4	Q5	R	S1	S2	S3	S4	S5
											
x2	x2	x2	x2	x1	x1	x2	x1	x1	x1	x1	x1
P1	P2	S3	P4	P5	26	27	28	29	30	31	32
											
x1	x1	x1	x1	x1	x49	x48	x12	x16	x4	x3	x3

ADULT ASSEMBLE / ASAMBLARE DE ADULTI

ASSEMBLY INSTRUCTION / INSTRUCTIUNI DE ASAMBLARE

TL8126

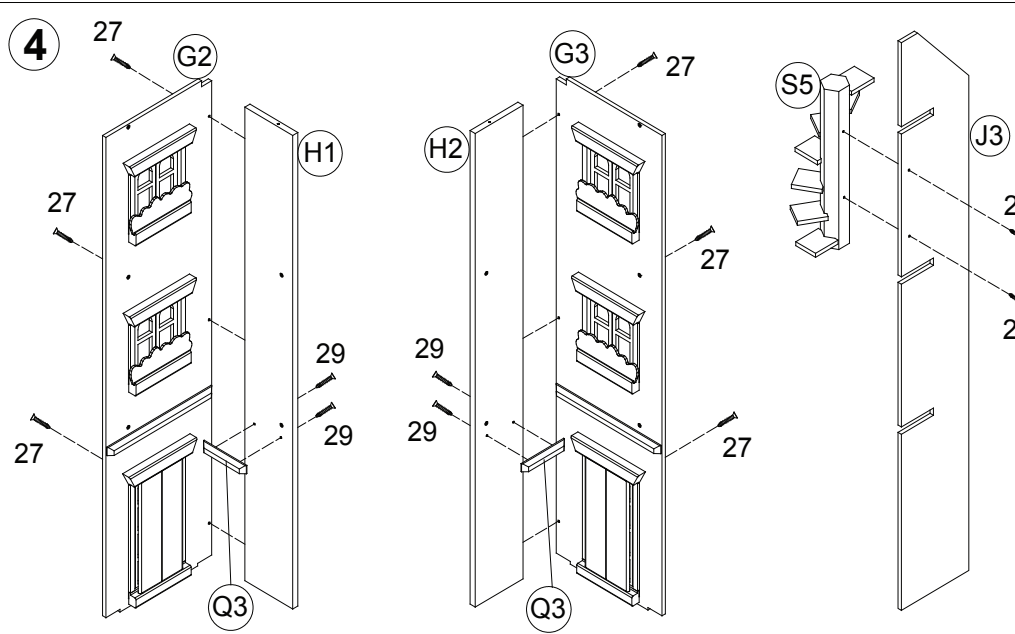
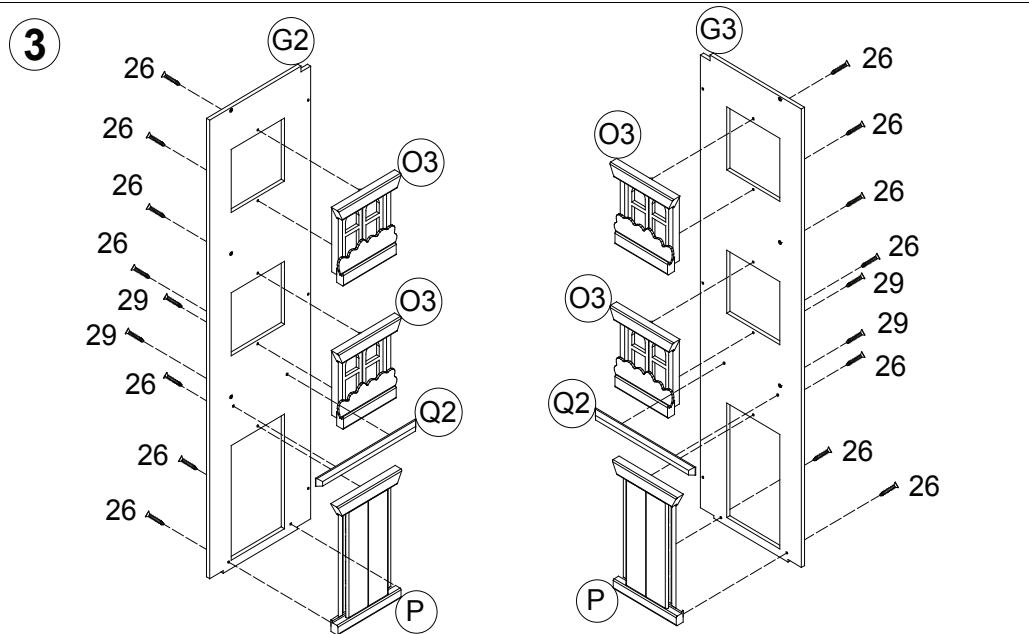
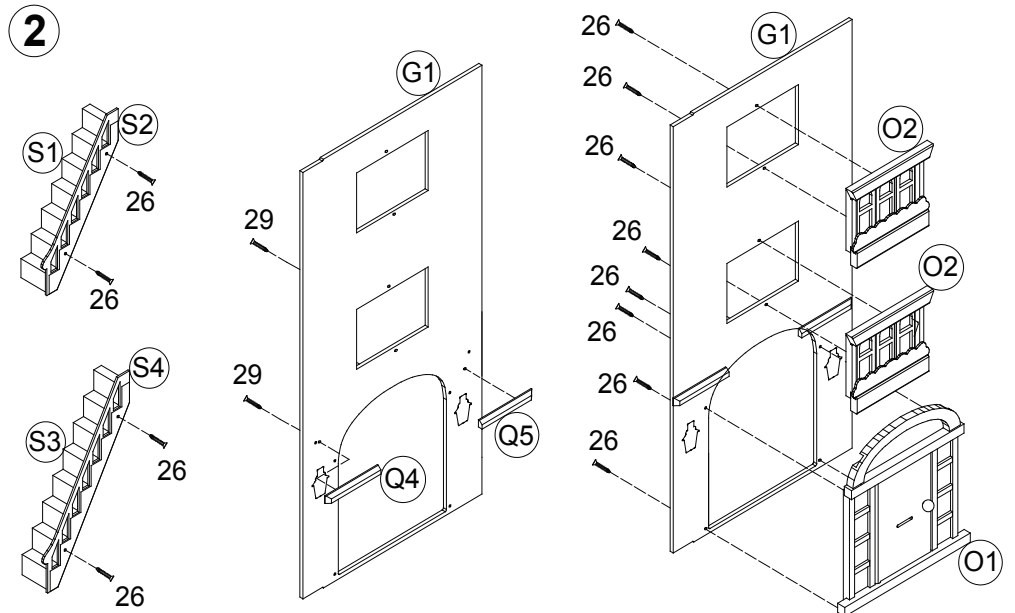
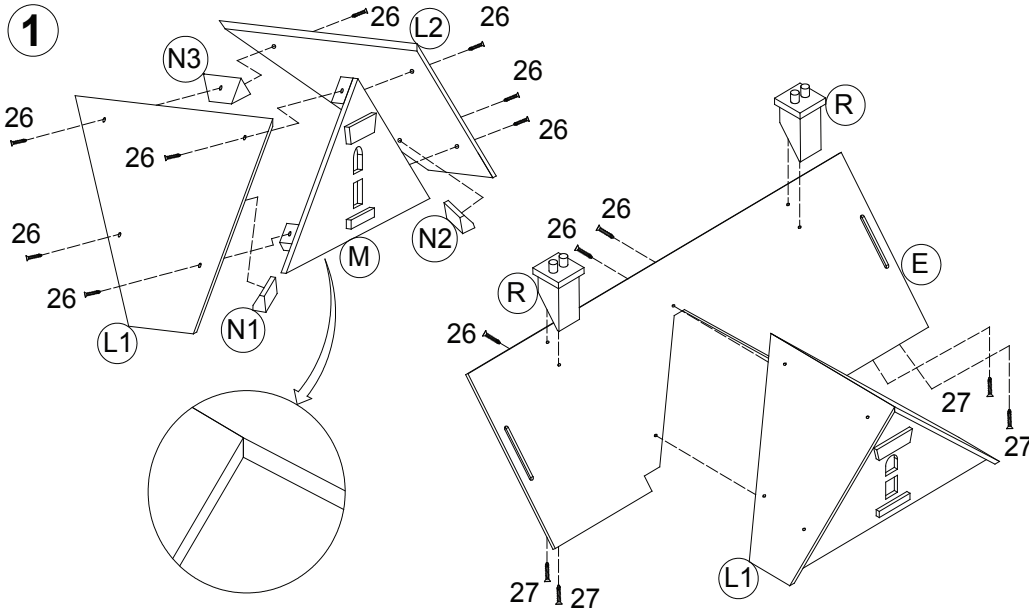

ADULT ASSEMBLE / ASAMBLARE DE ADULTI

ASSEMBLY INSTRUCTION / INSTRUCTIUNI DE ASAMBLARE

TL8126

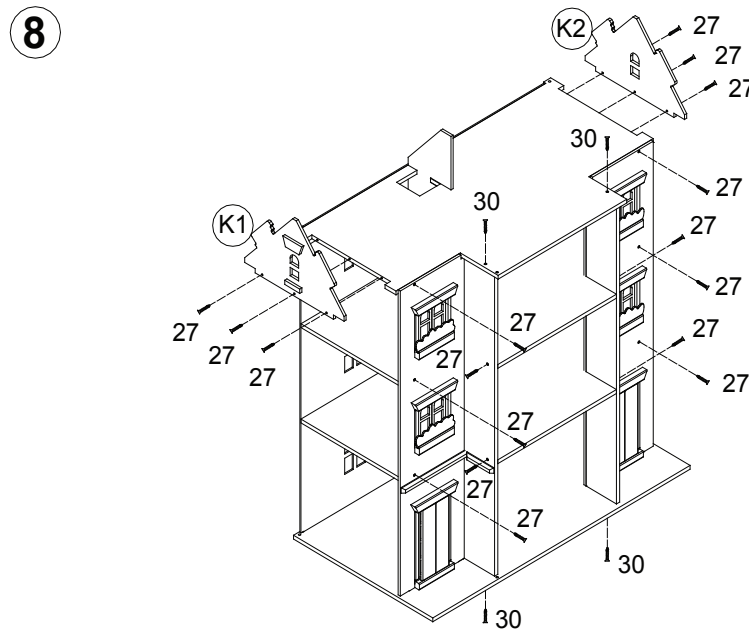
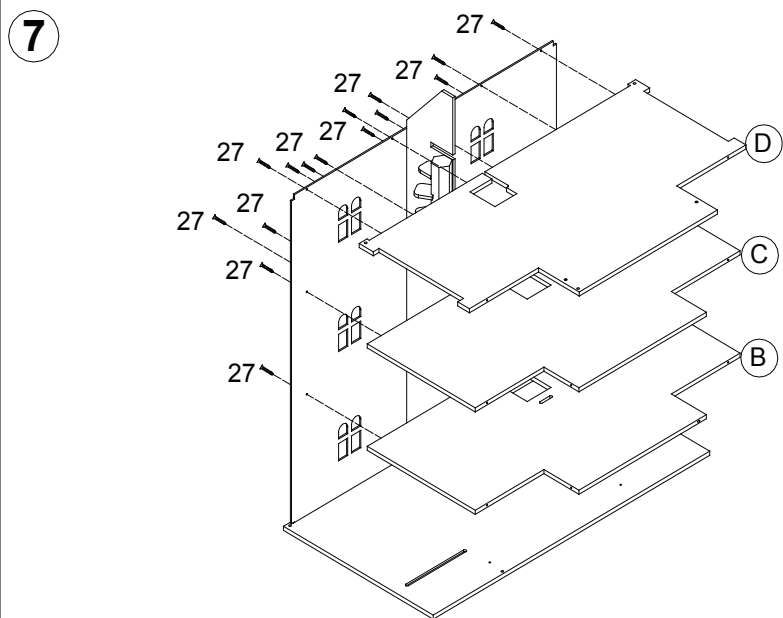
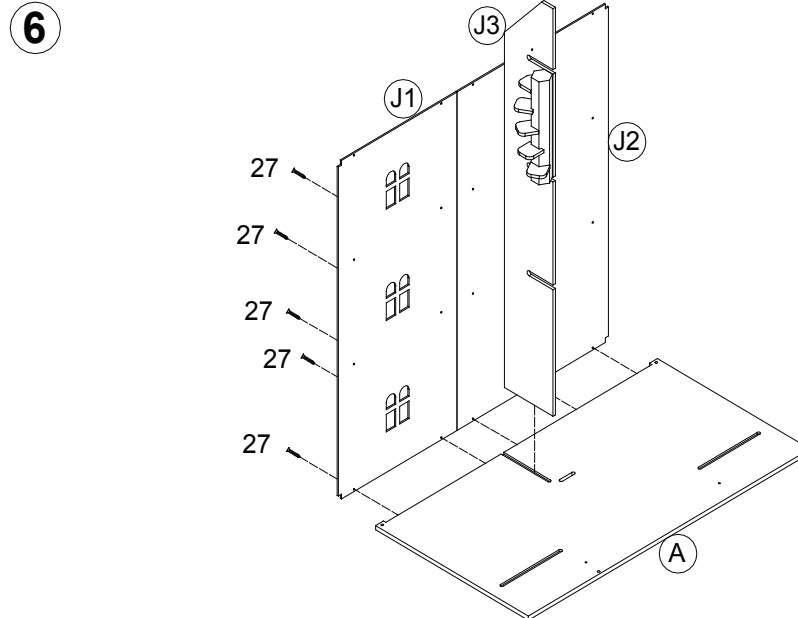
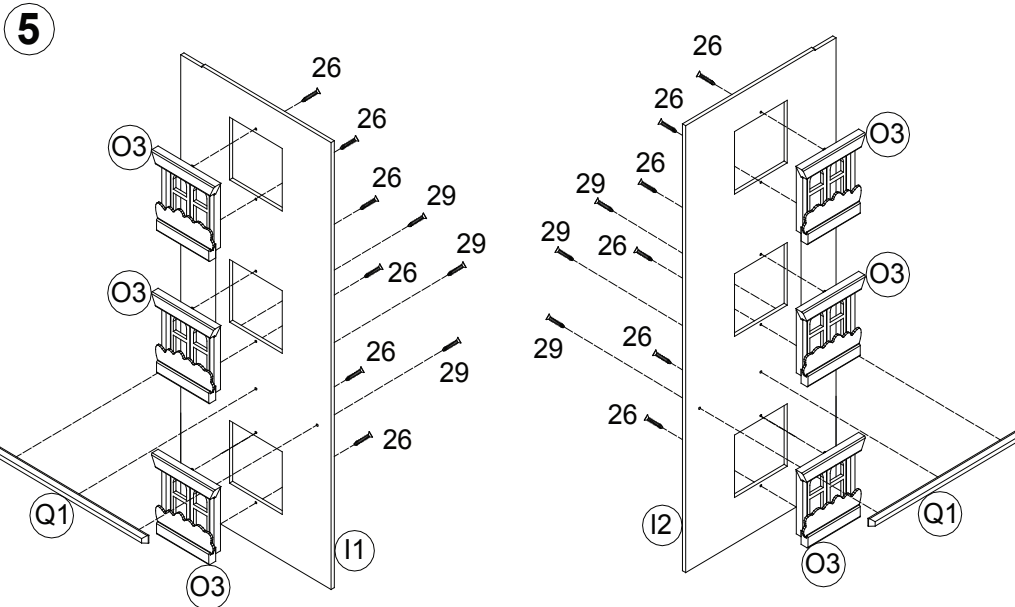

ADULT ASSEMBLE / ASAMBLARE DE ADULTI

ASSEMBLY INSTRUCTION / INSTRUCTIUNI DE ASAMBLARE

TL8126

9

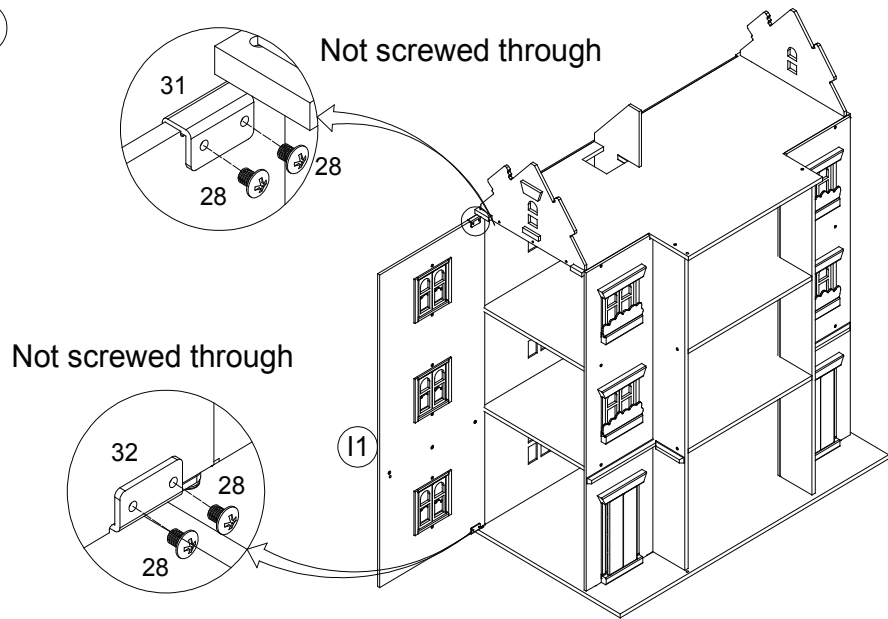

10

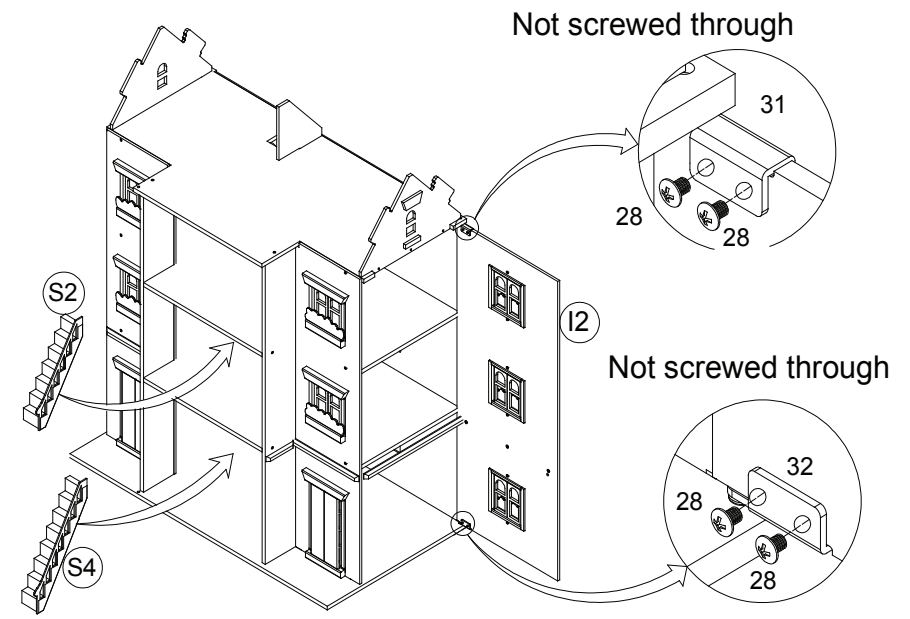

11

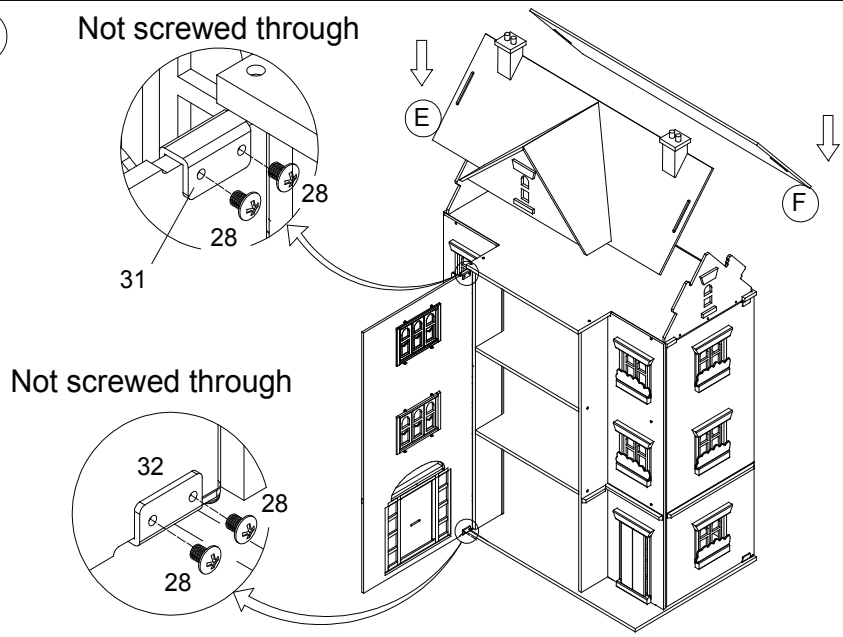

Complete

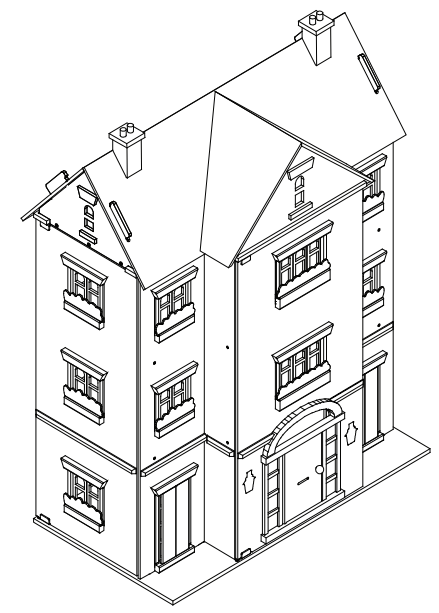

ADULT ASSEMBLE / ASAMBLARE DE ADULTI