











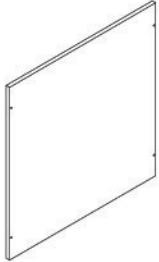
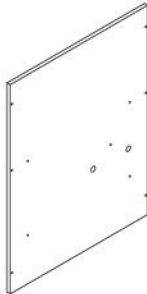
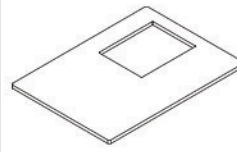
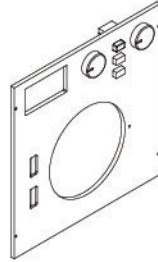

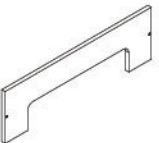

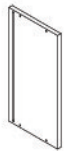
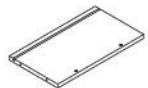
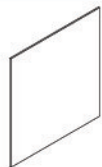
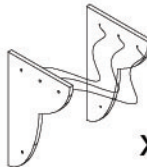

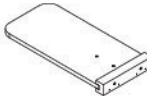
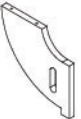

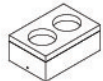

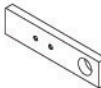

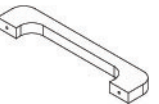
PART LIST

ITEM : TL8209

 x1	 x1	 x1	 x1	 x1	 x1	 x1	 x1	
 x1	 x1	 x2	 x1	 x1	 x1	 x1	 x1	
 x1	 x2	 x1	 x1	 x2	 x1	 x1	 x1	
 x2	 x1	 x1	 x2	 x1	 19 mm x4	 24 mm x54	 10 mm x16	 x4

ADULT ASSEMBLY REQUIRED. This package contains small parts which are for adult assembly only. Please make sure all screws and bolts are securely fastened during assembly. Upon completion please double check before using the toy. Failure to follow assembly instruction will cause damages to the toy and potentially result in an injury to children.

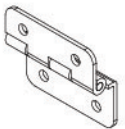
ASSEMBLY INSTRUCTION

ITEM :TL8209

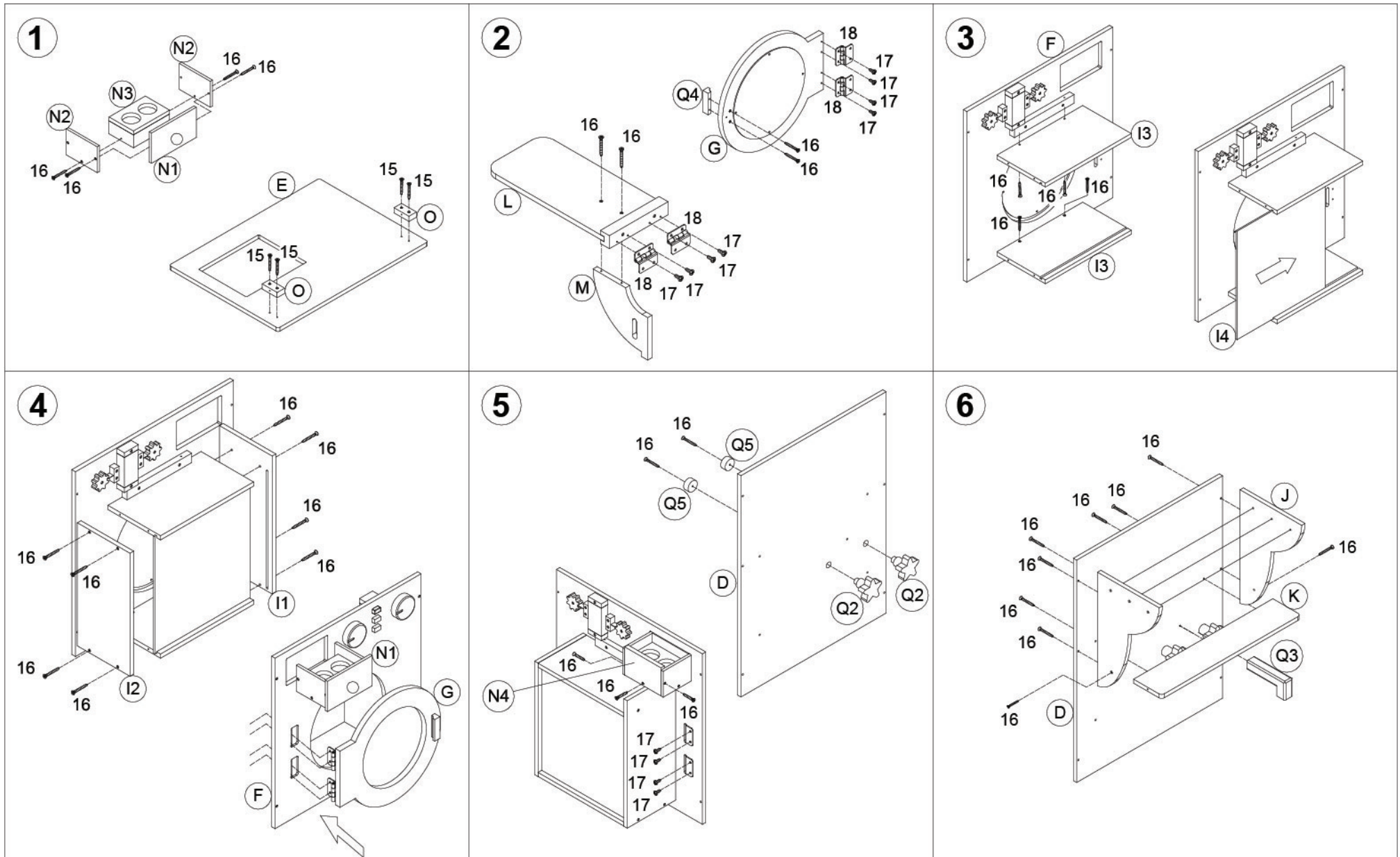

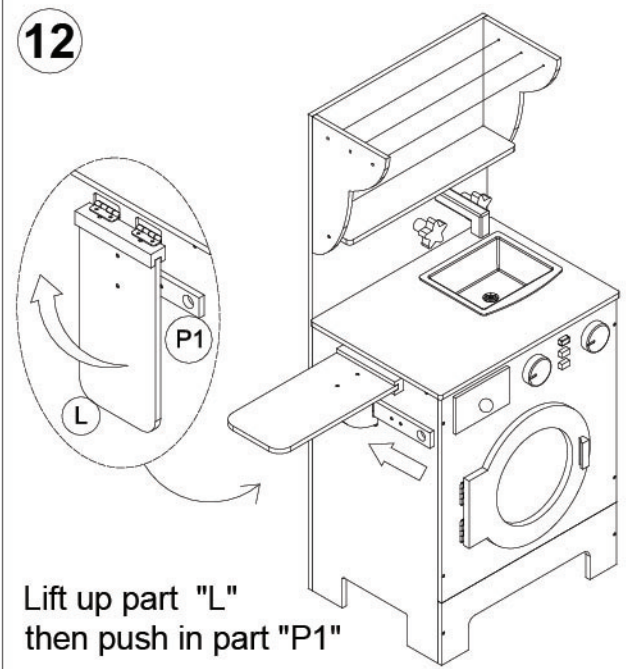
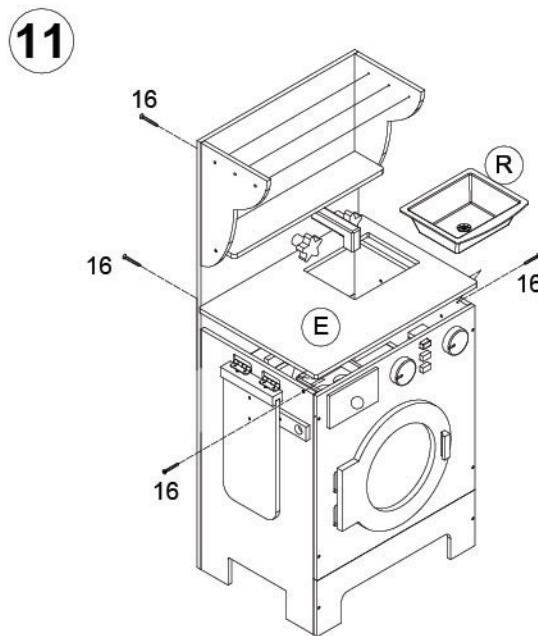
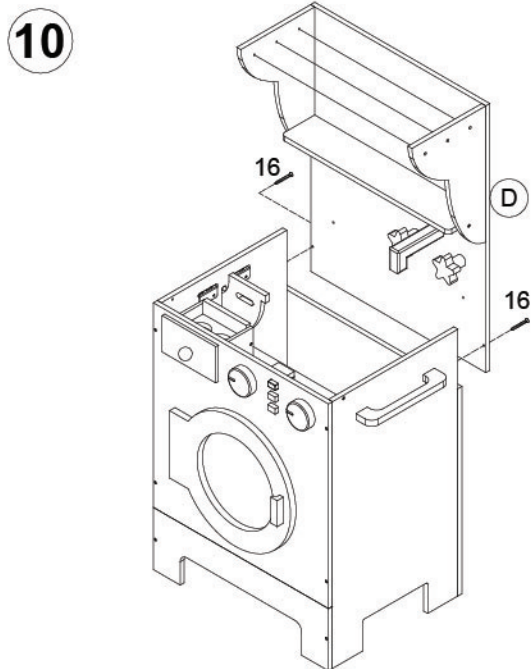
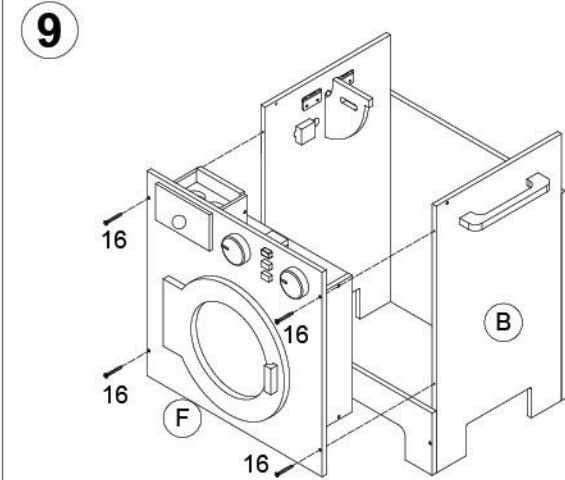
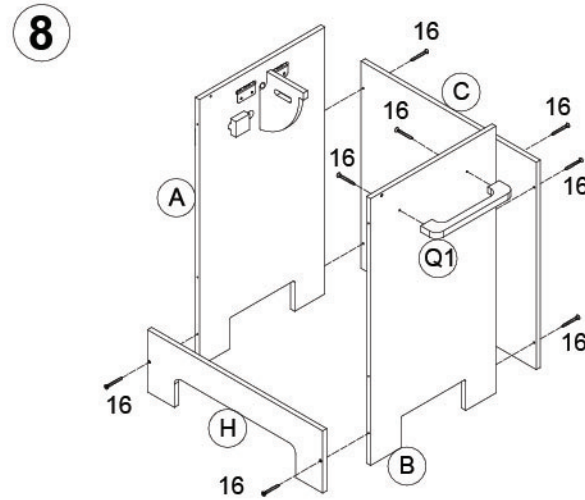
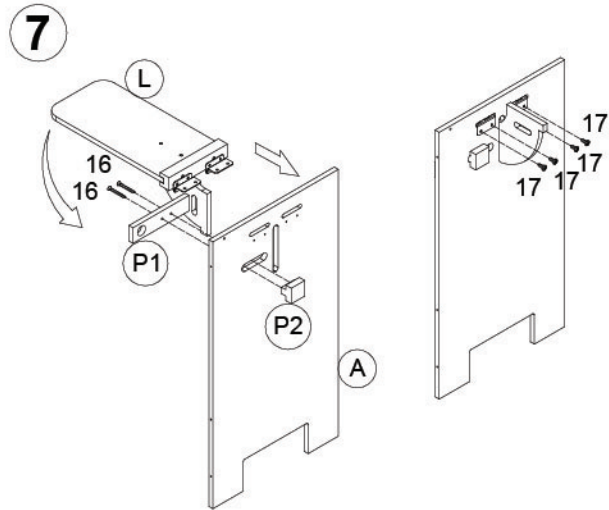

ASSEMBLY INSTRUCTION

ITEM :TL8209

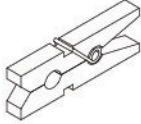
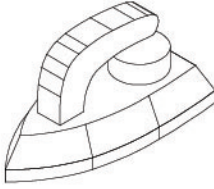
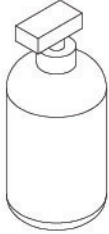
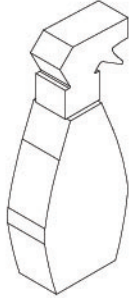

PART LIST

ITEM : TL8209

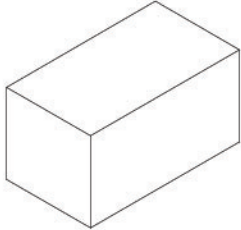
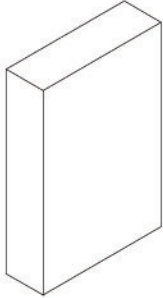
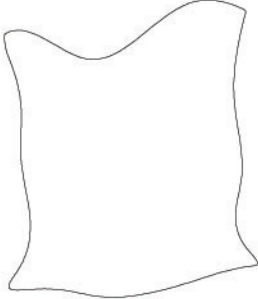
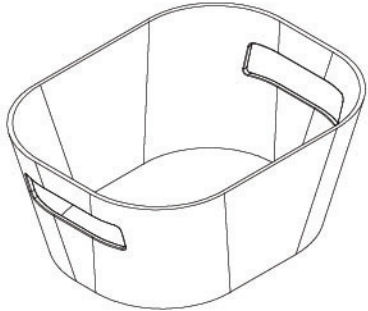
P1	P2	P3	P4
 x2	 x6	 x1	 x1
P5	P6	P7	
 x1	 x1	 x1	
P8	P9	P10	
 x1	 x4	 x1	