

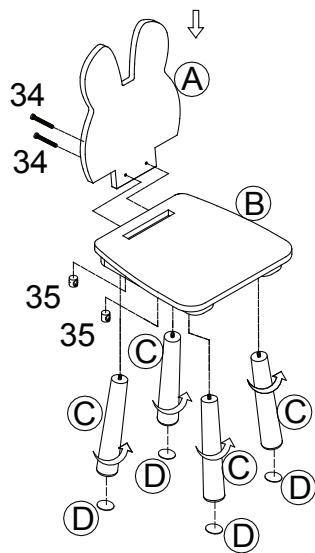

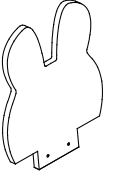
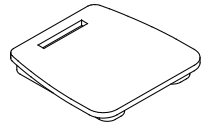

ASSEMBLY INSTRUCTION / INSTRUCTIUNI DE ASAMBLARE

TL8812

1

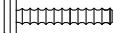

PART LIST / PARTI COMPONENTE	
A	 x1
B	 x1
C	 x4
D	 x4
34	 38 mm x2
35	 x2
FF	 x1

Complete / COMPLET

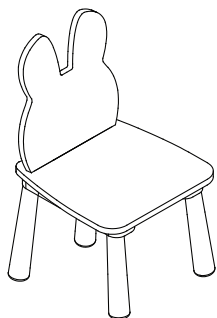







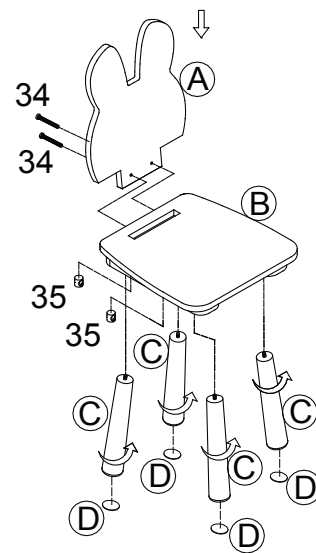

- GREUTATE MAXIMA: 30 KG
- ASAMBLAREA SE FACE DE UN ADULT COMPETENT
- IN TIMPUL ASAMBLARII COPIII TREBUIE TINUTI DEPARTE
- NU UTILIZATI PRODUSUL DACA LIPSESTE VREUN COMPONENT

ASSEMBLY INSTRUCTION / INSTRUCTIUNI DE ASAMBLARE

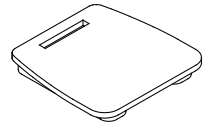
TL8812

1



PART LIST / PARTI COMPONENTE	
A	 x1
B	 x1
C	 x4
D	 x4
34	 38 mm x2
35	 x2
FF	 x1

Complete / COMPLET

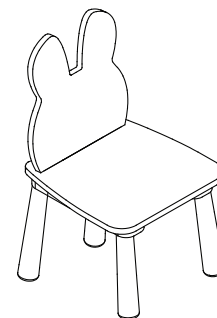

- GREUTATE MAXIMA: 30 KG
- ASAMBLAREA SE FACE DE UN ADULT COMPETENT
- IN TIMPUL ASAMBLARII COPIII TREBUIE TINUTI DEPARTE
- NU UTILIZATI PRODUSUL DACA LIPSESTE VREUN COMPONENT